

PORTE PALIÈRE

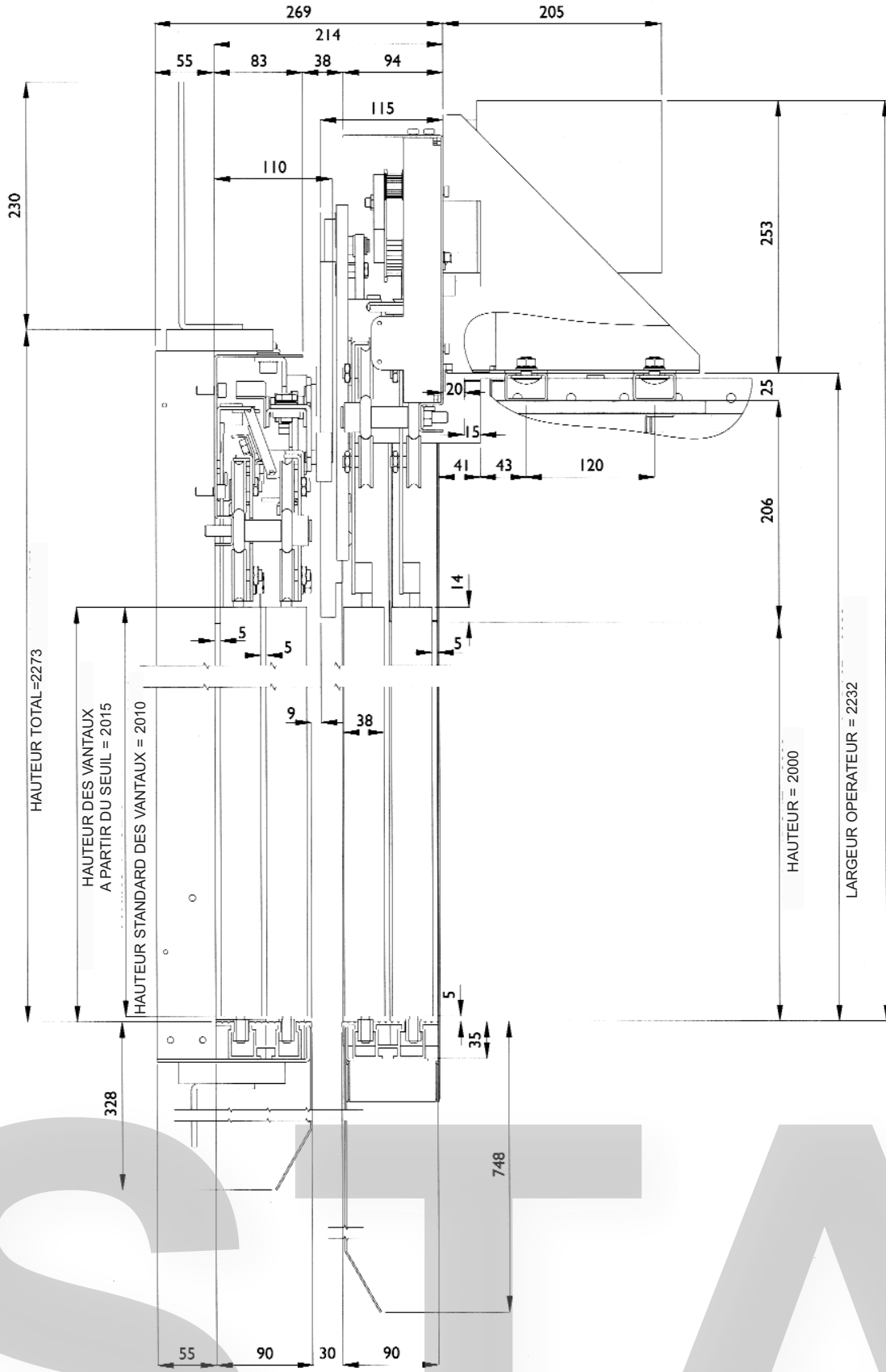

PORTE CABINE

A2

Ver. 03

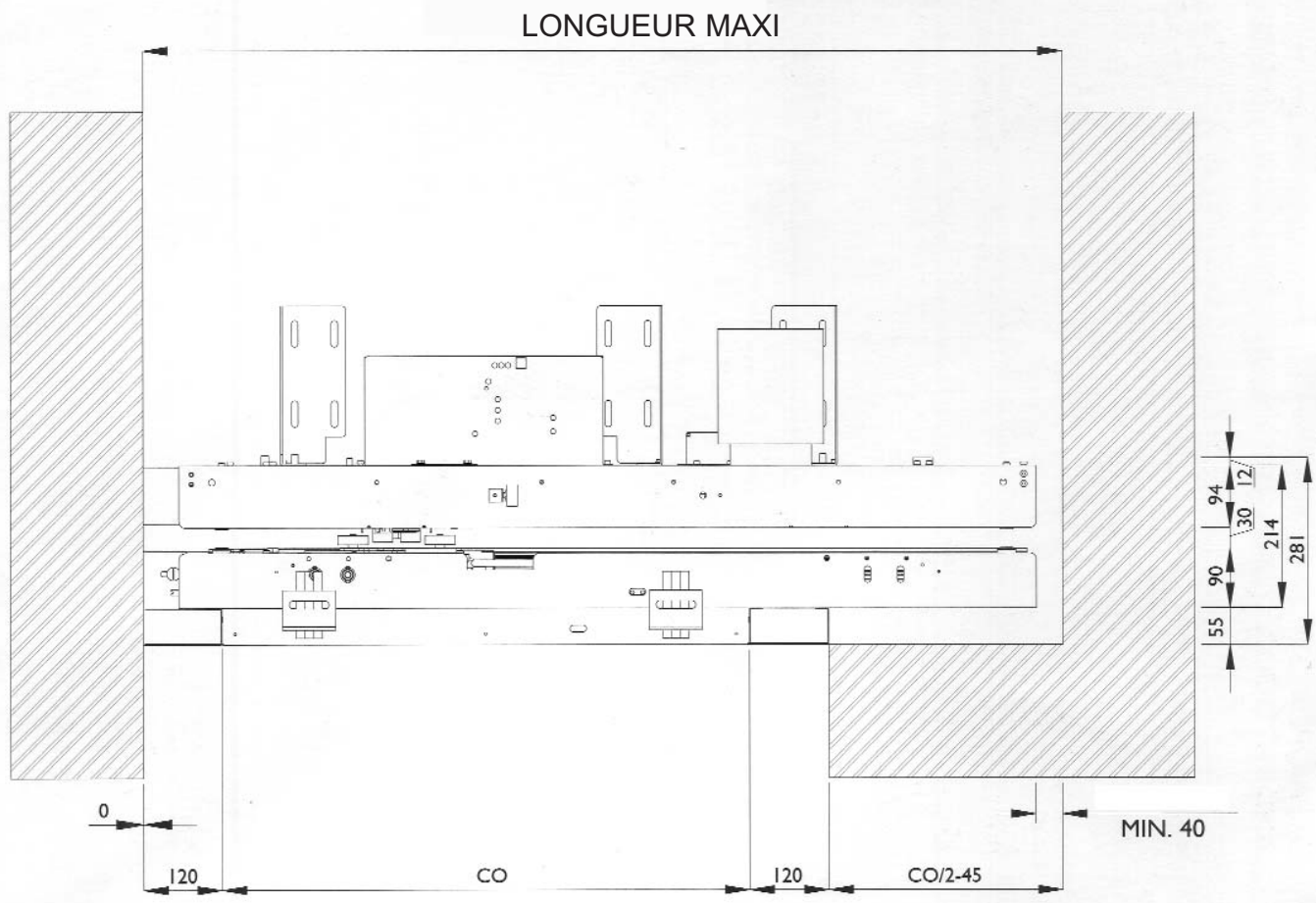

PORTE TELESCOPIQUE 2 VANTAUX

A3

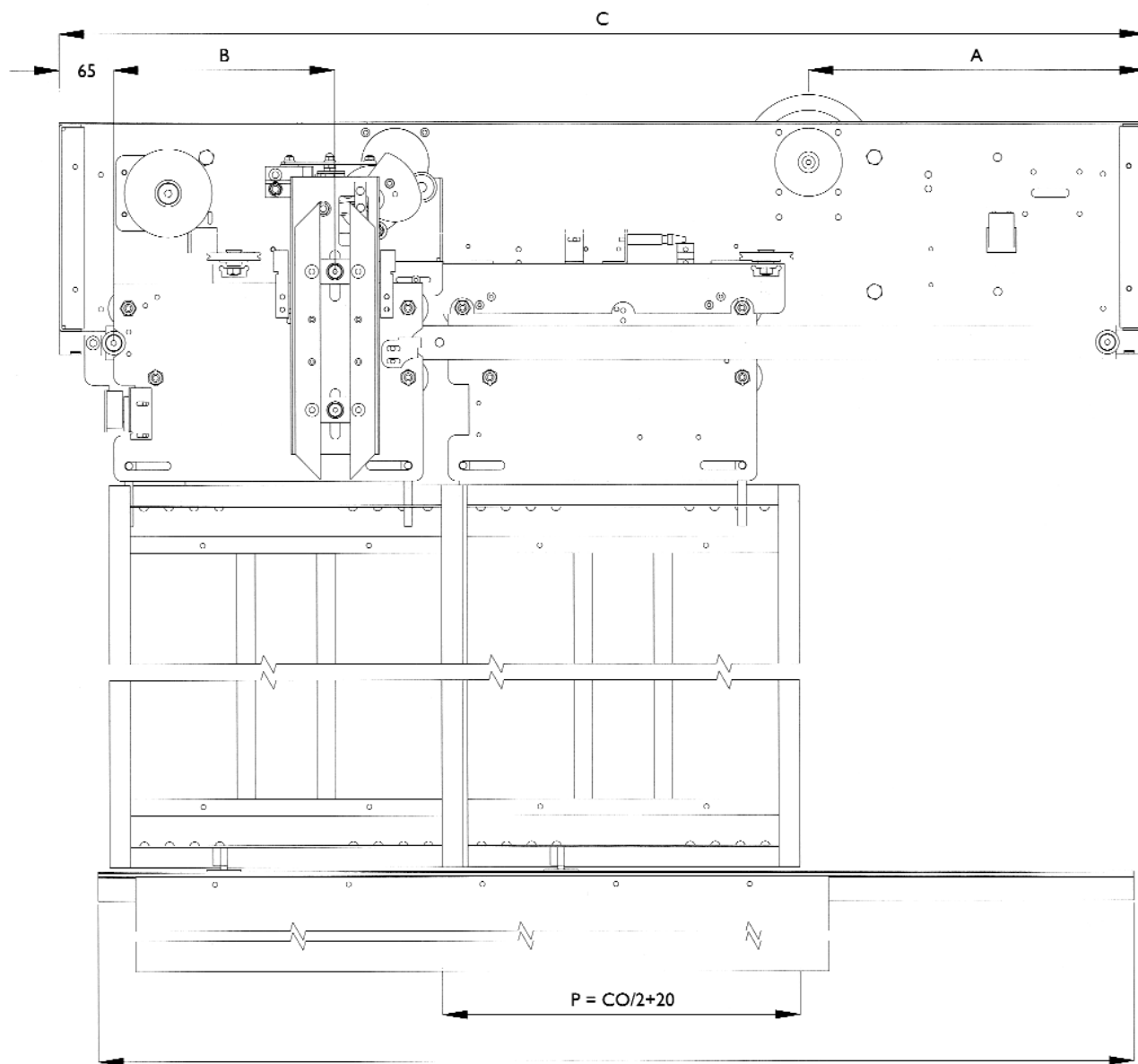

LONGUEUR SEUIL = CO+P+20

PORTE CABINE TELESCOPIQUE 2 VANTAUX

longueur -
seuil

A4

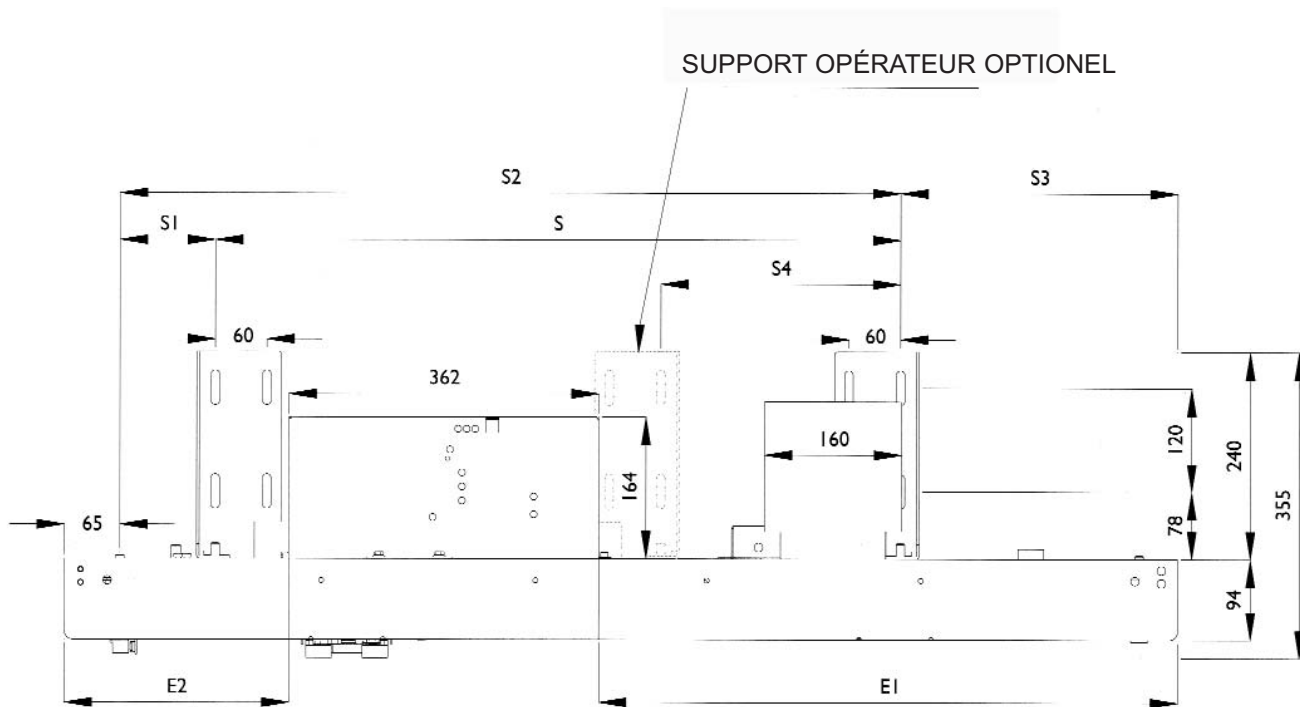

VUE DESSUS OPÉRATEUR CABINE

PORTE CABINE TELESCOPIQUE 2 VANTAUX

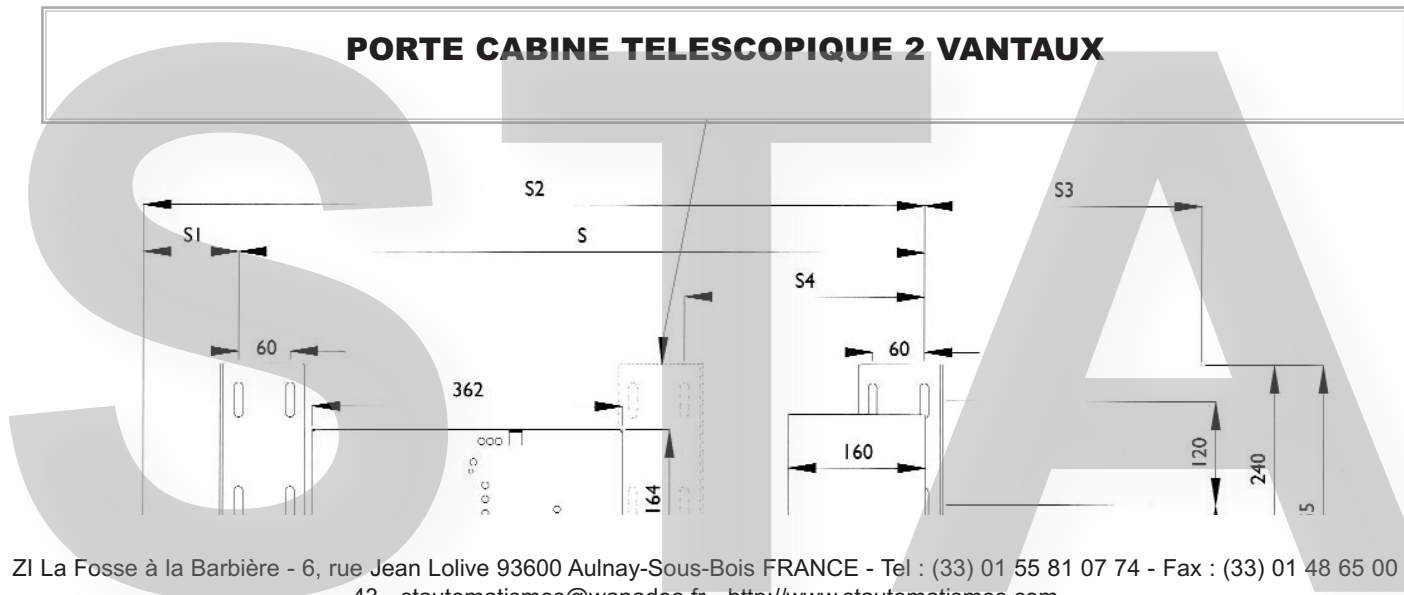

A5

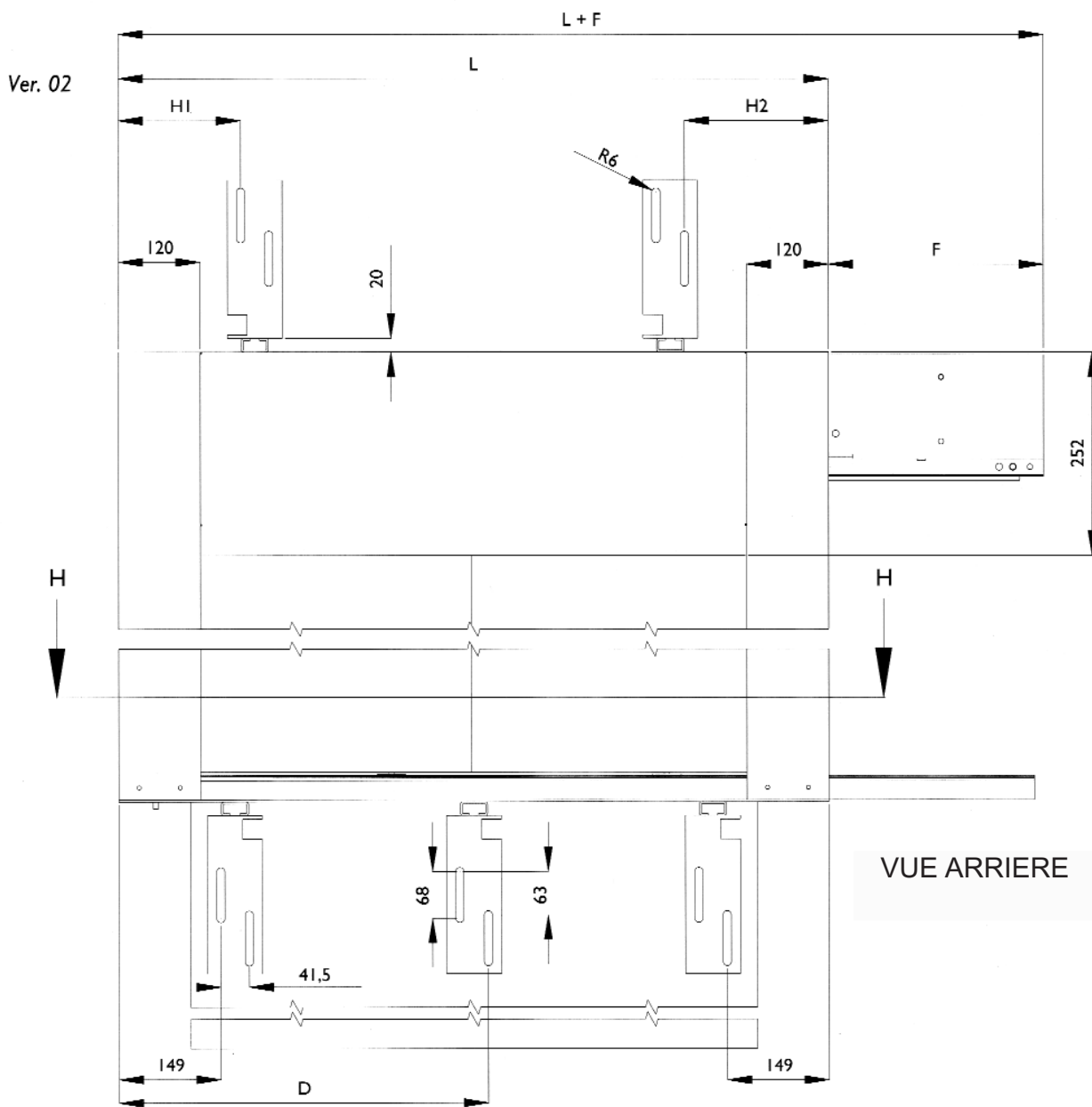

PORTE PALIERE TELESCOPIQUE 2 VANTAUX

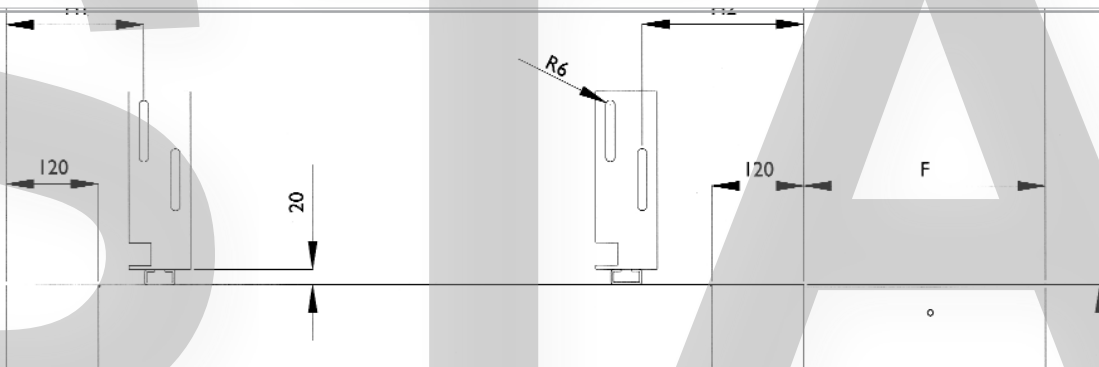

A6

LONGUEUR SEUIL

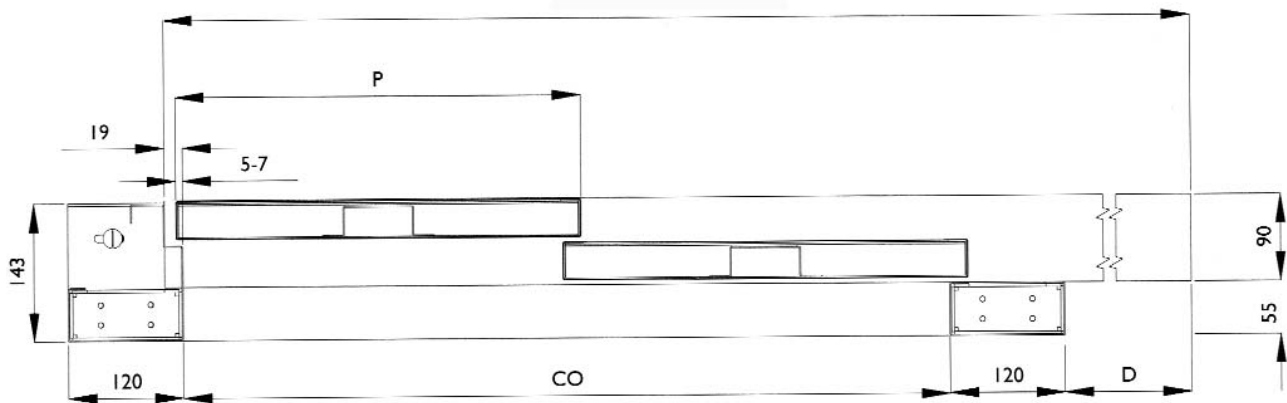

VUE DU PALIER

PORTE PALIERE TELESCOPIQUE 2 VANTAUX



A7

Ver. 01

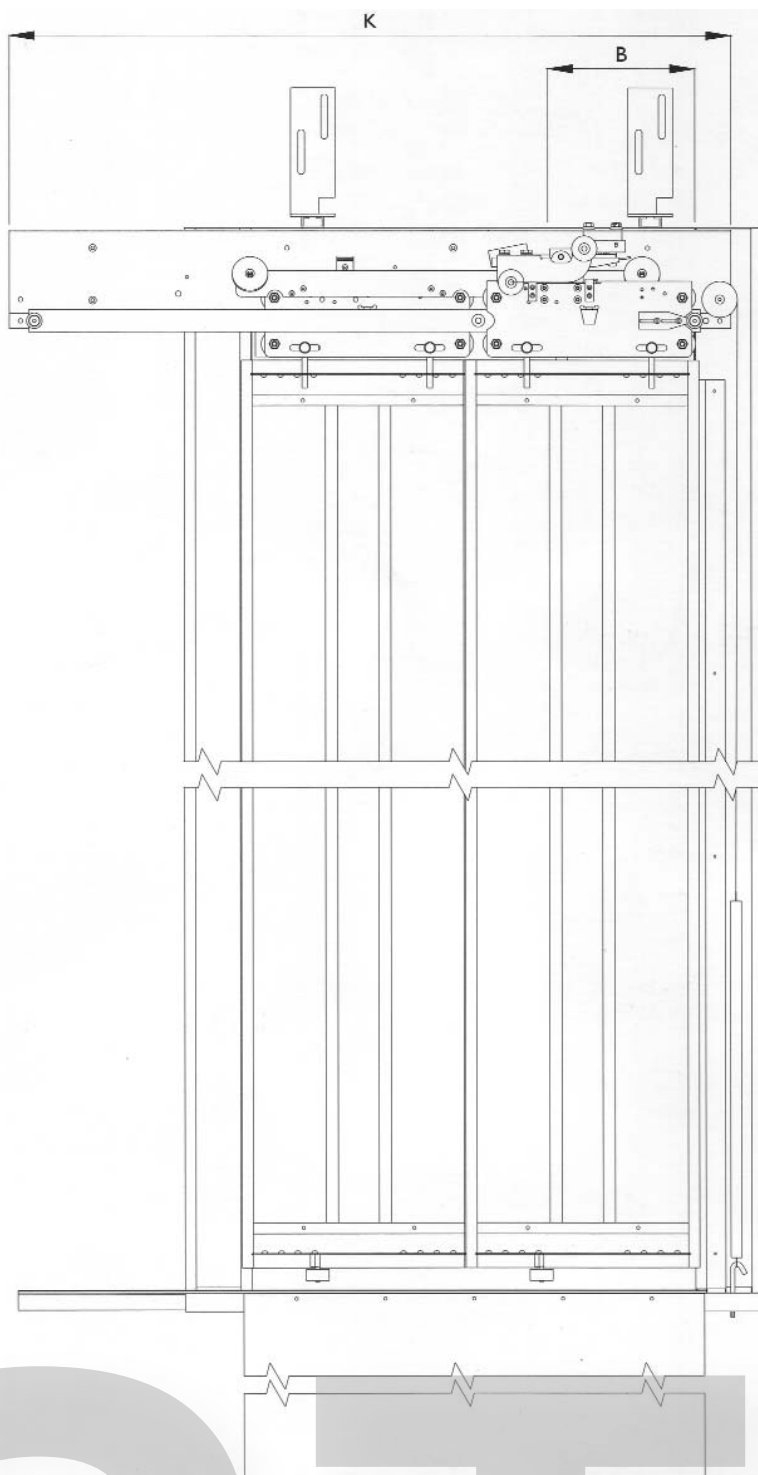

VUE ARRIERE

PORTE PALIERE TELESCOPIQUE 2 VANTAUX

BI

Ver. 04

PORTE PALIERE

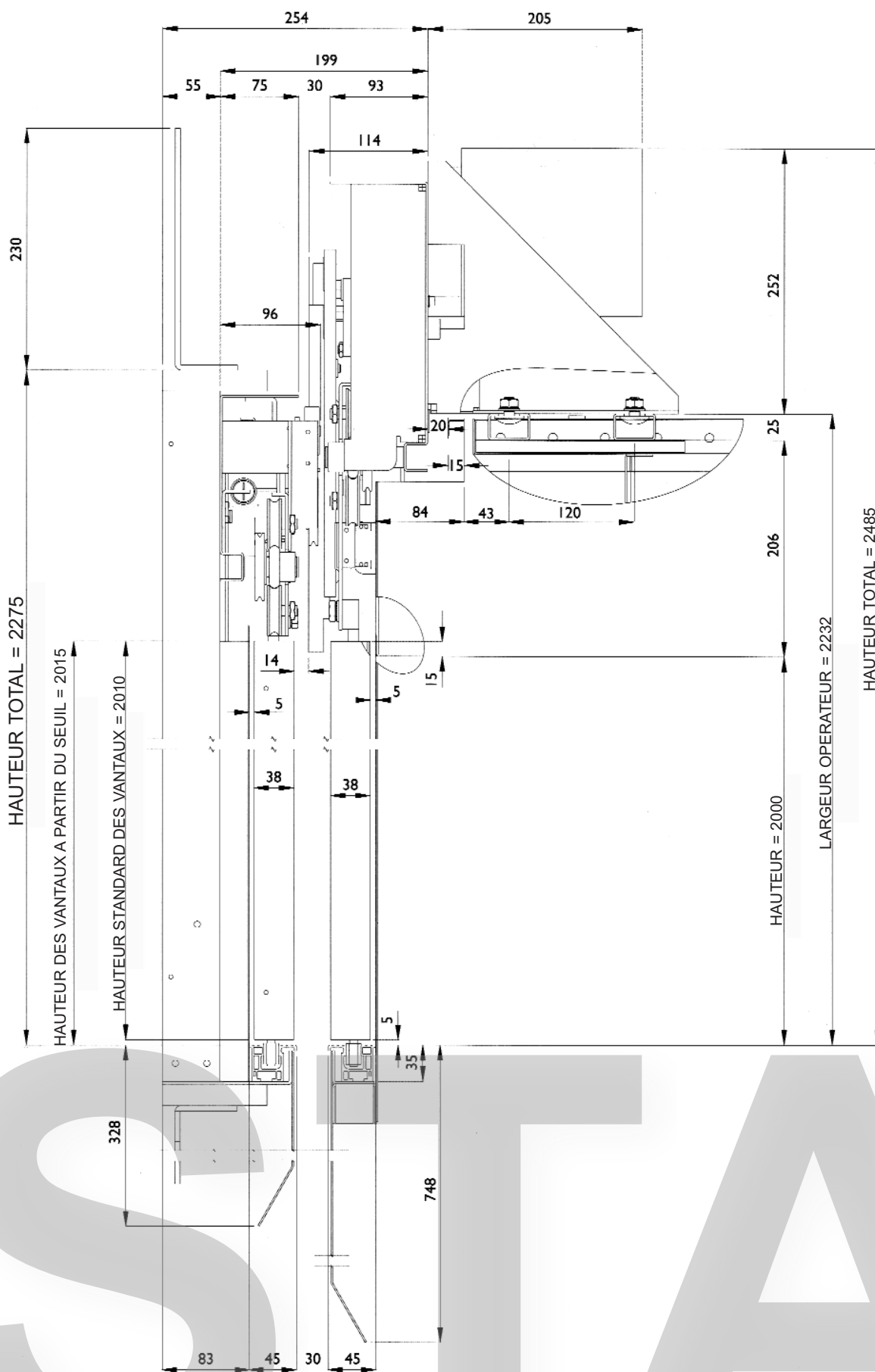

PORTE CABINE

B2

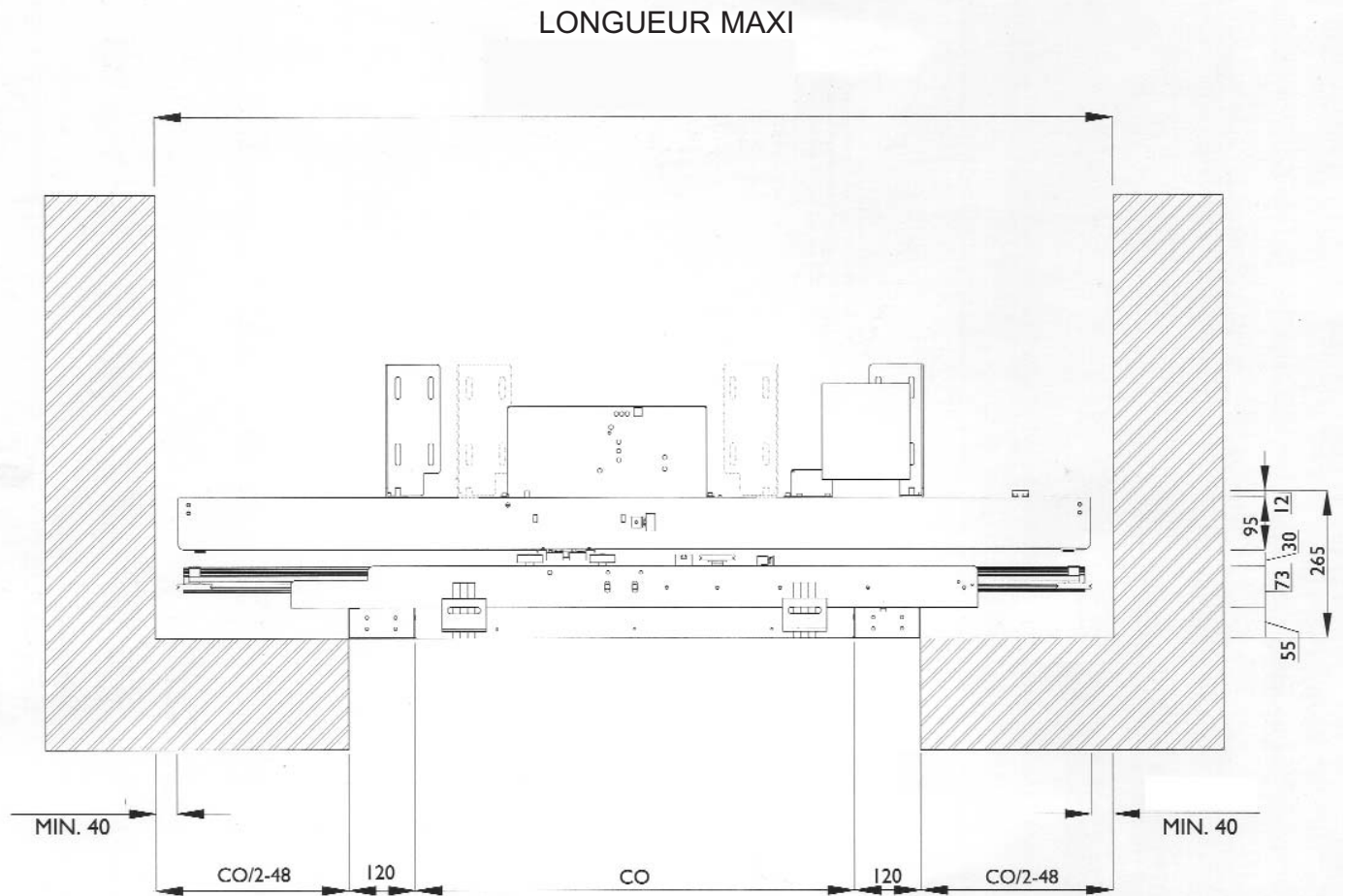

PORTE 2 VANTAUX OUVERTURE CENTRALE

LONGUEUR
MAX

B3

Ver. 01

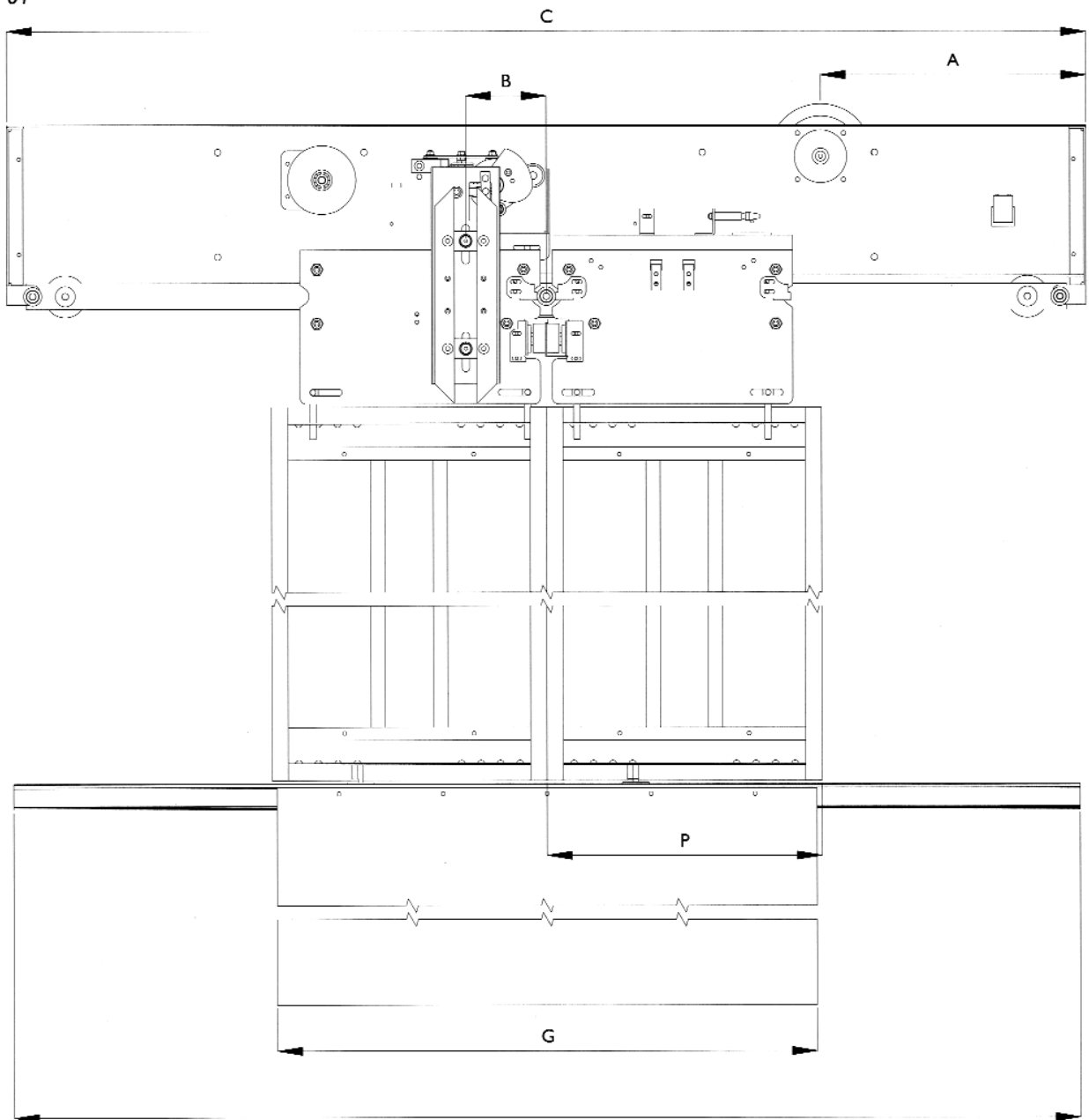

LONGUEUR SEUIL = CO+2P

PORTE CABINE 2 VANTAUX OUVERTURE CENTRALE

longueur seuil

B4

SUPPORT OPÉRATEUR
OPTIONEL

SUPPORT OPÉRATEUR OPTIONEL

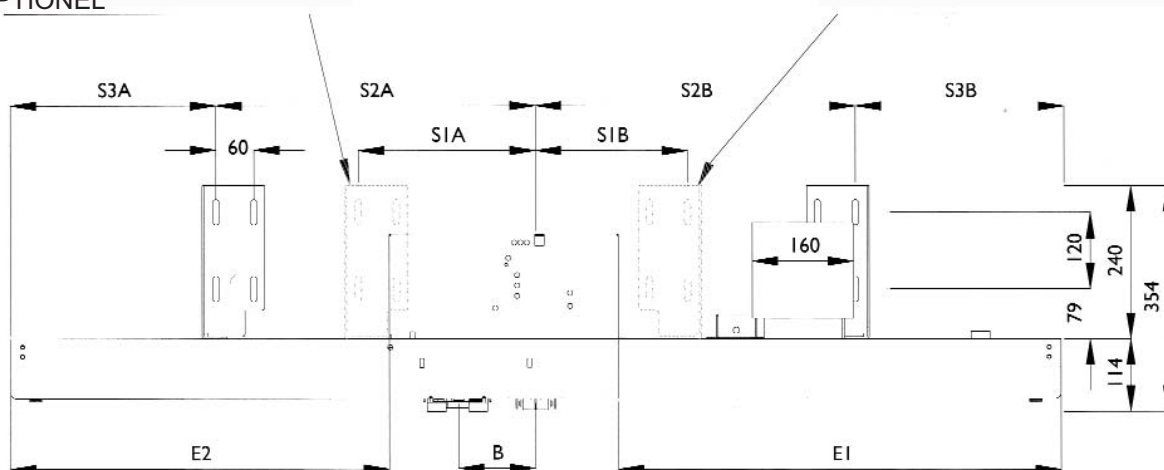

VUE DESSUS OPÉRATEUR CABINE

PORTE CABINE 2 VANTAUX OUVERTURE CENTRALE

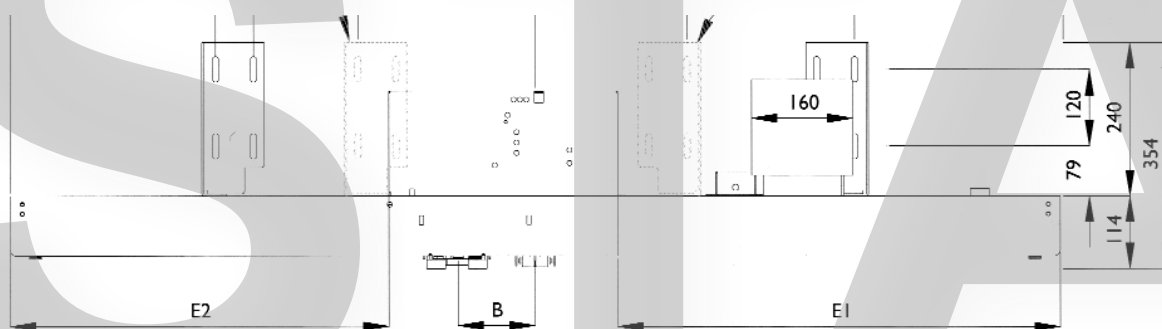

B5

Ver. 03

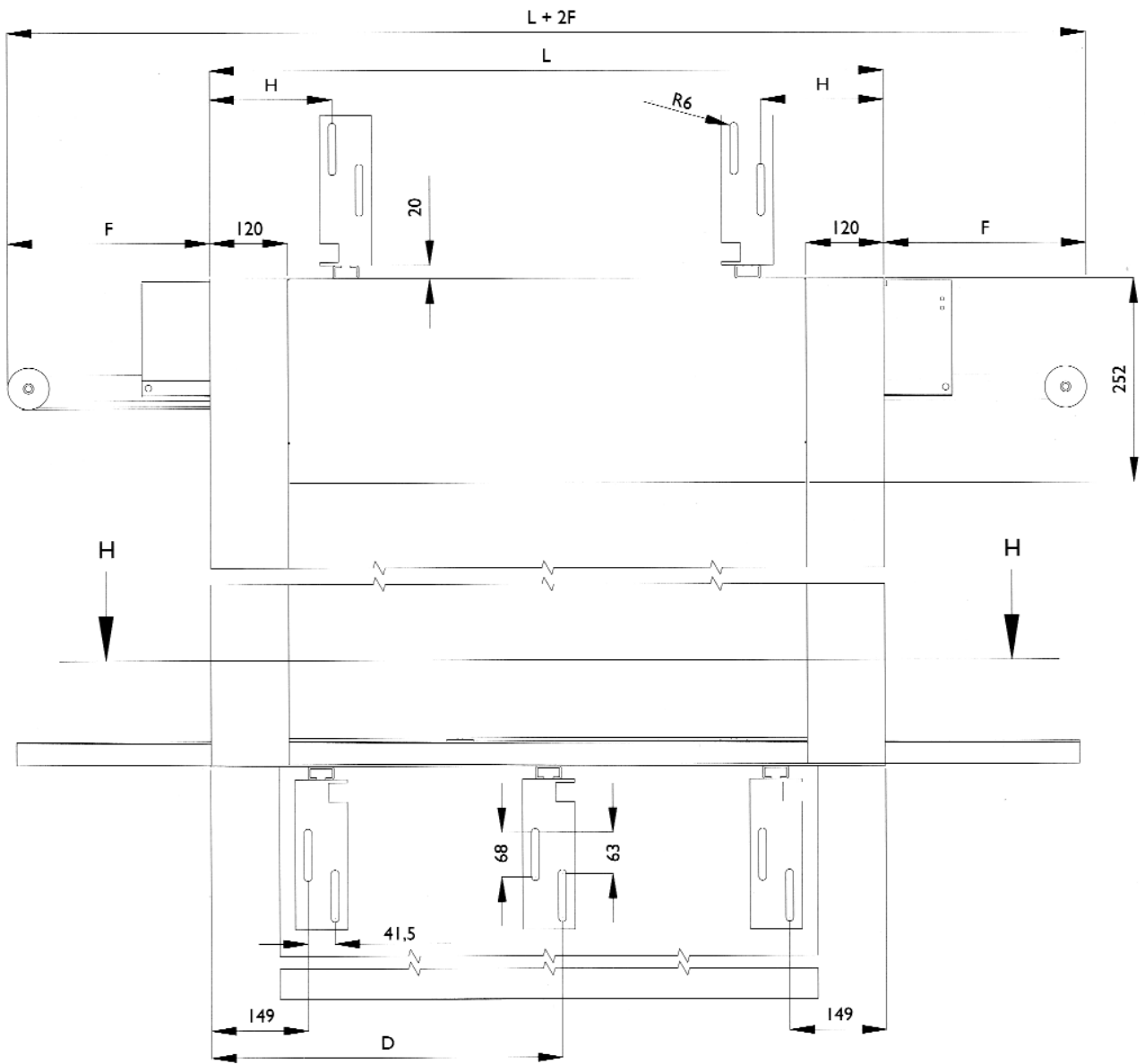

PORTE PALIERE TELESCOPIQUE 2 VANTAUX

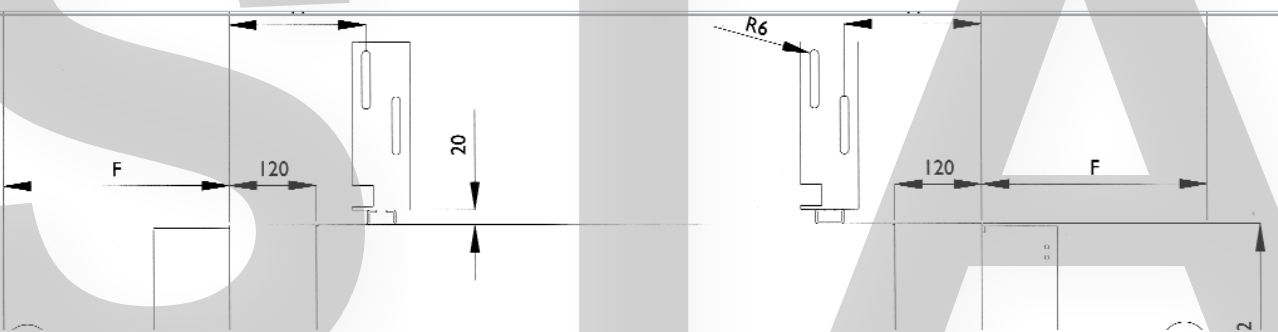

B6

LONGUEUR SEUIL

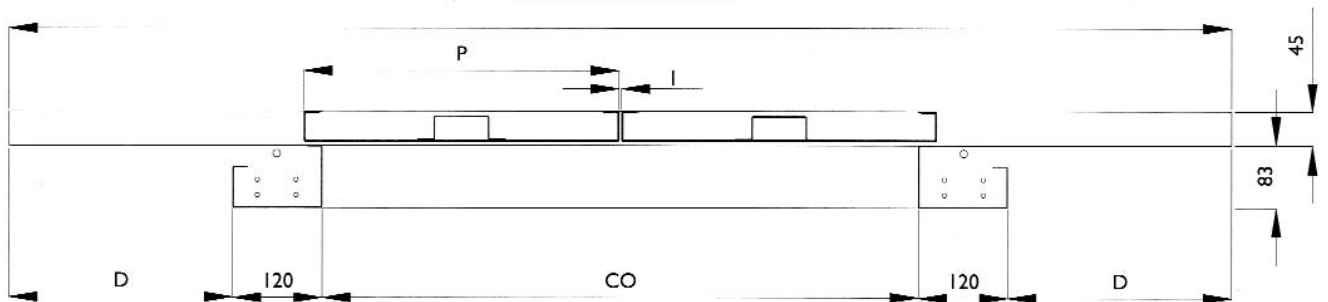

VUE DU PALIER

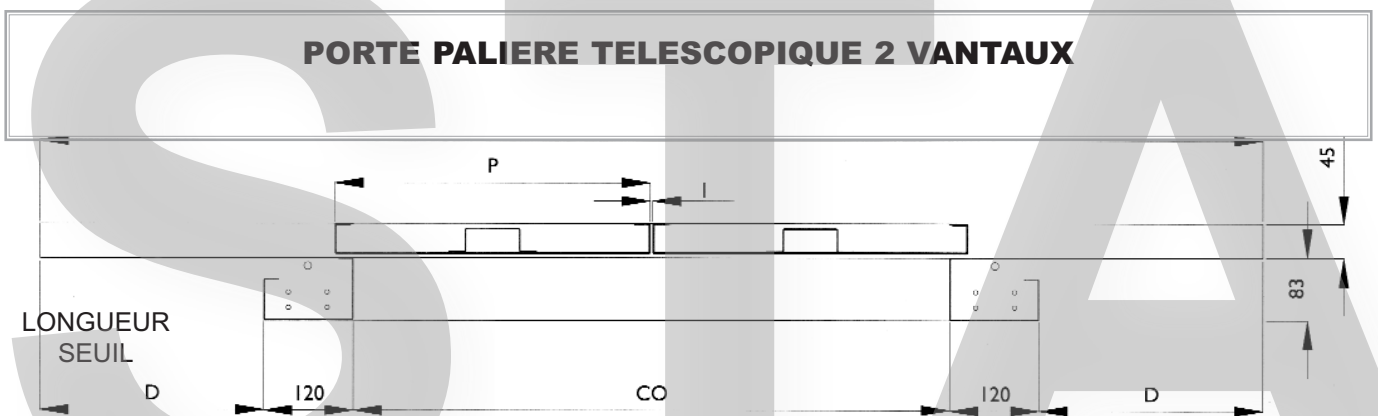

B7
Ver. 01

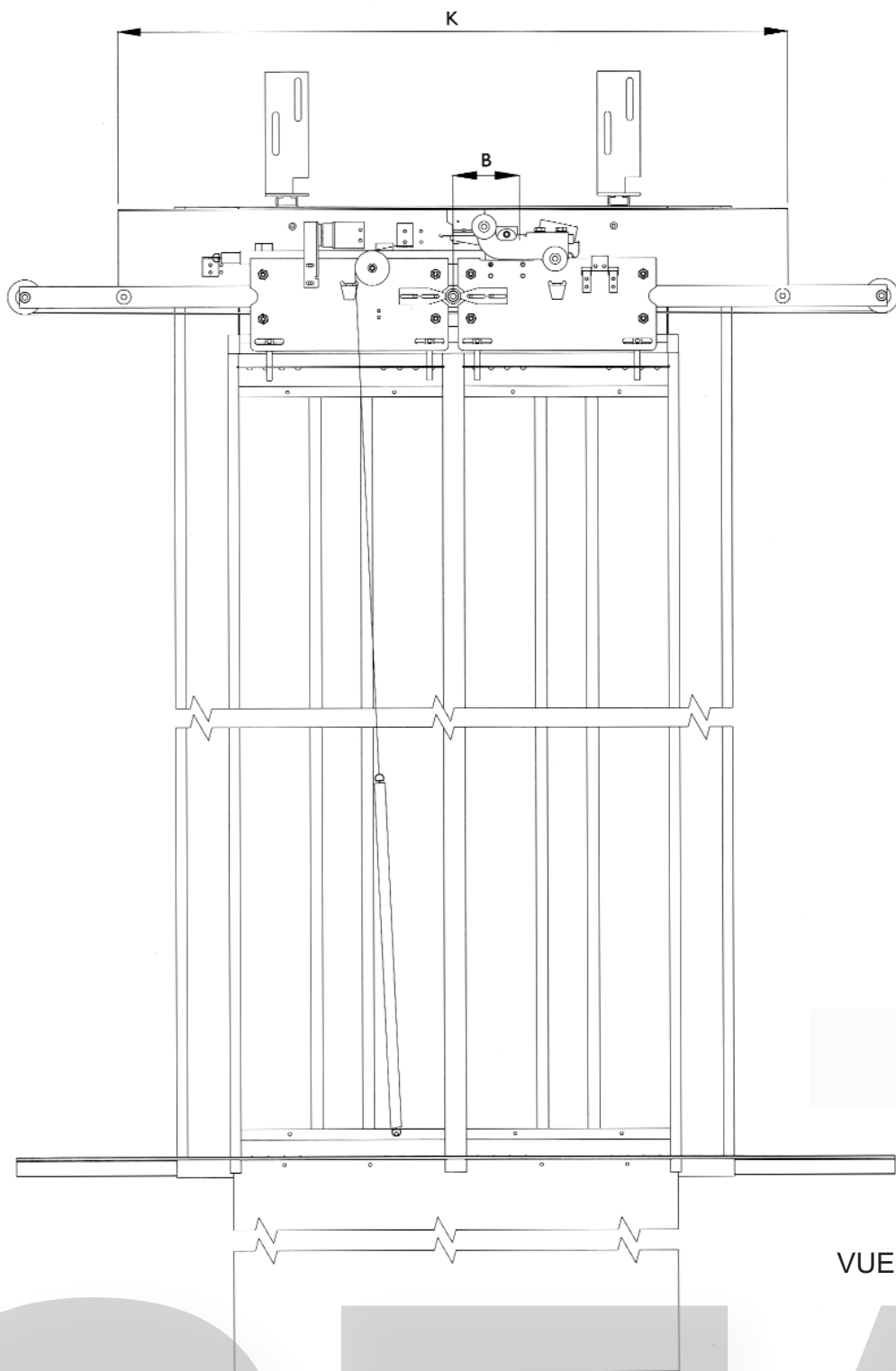

VUE ARRIERE

PORTE CABINE 2 VANTAUX OUVERTURE CENTRALE

ver. 01

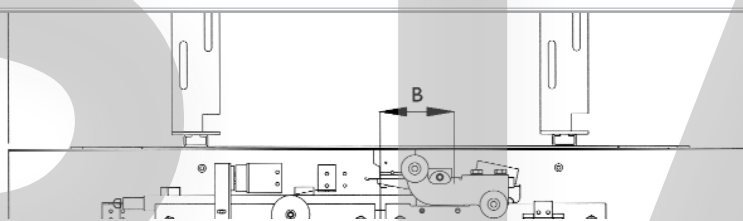

D2

Ver. 03

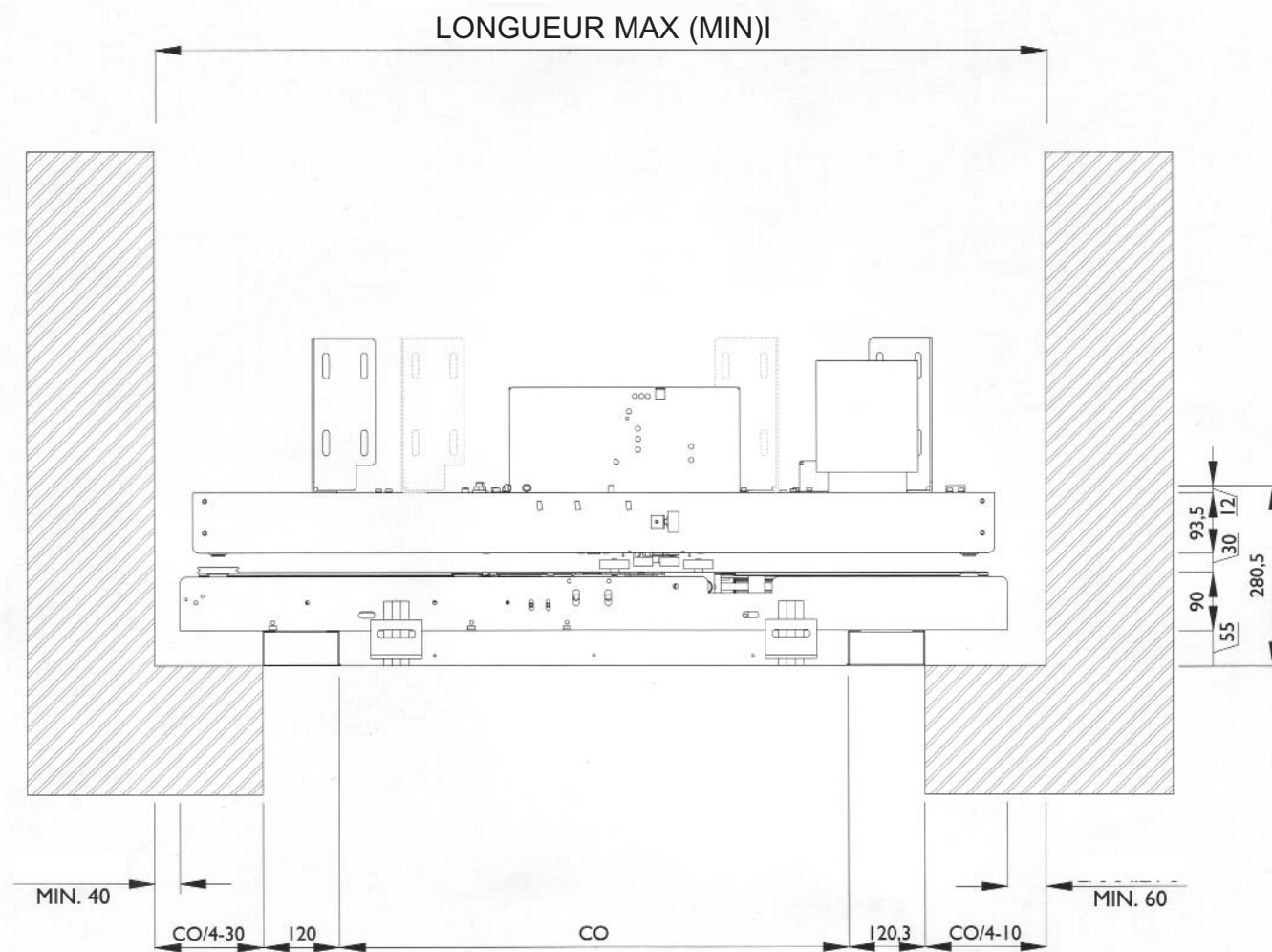

PORTE 4 VANTAUX OUVERTURE CENTRALE

longueur max

D3

Ver. 01

LONGUEUR MAXI (MIN)

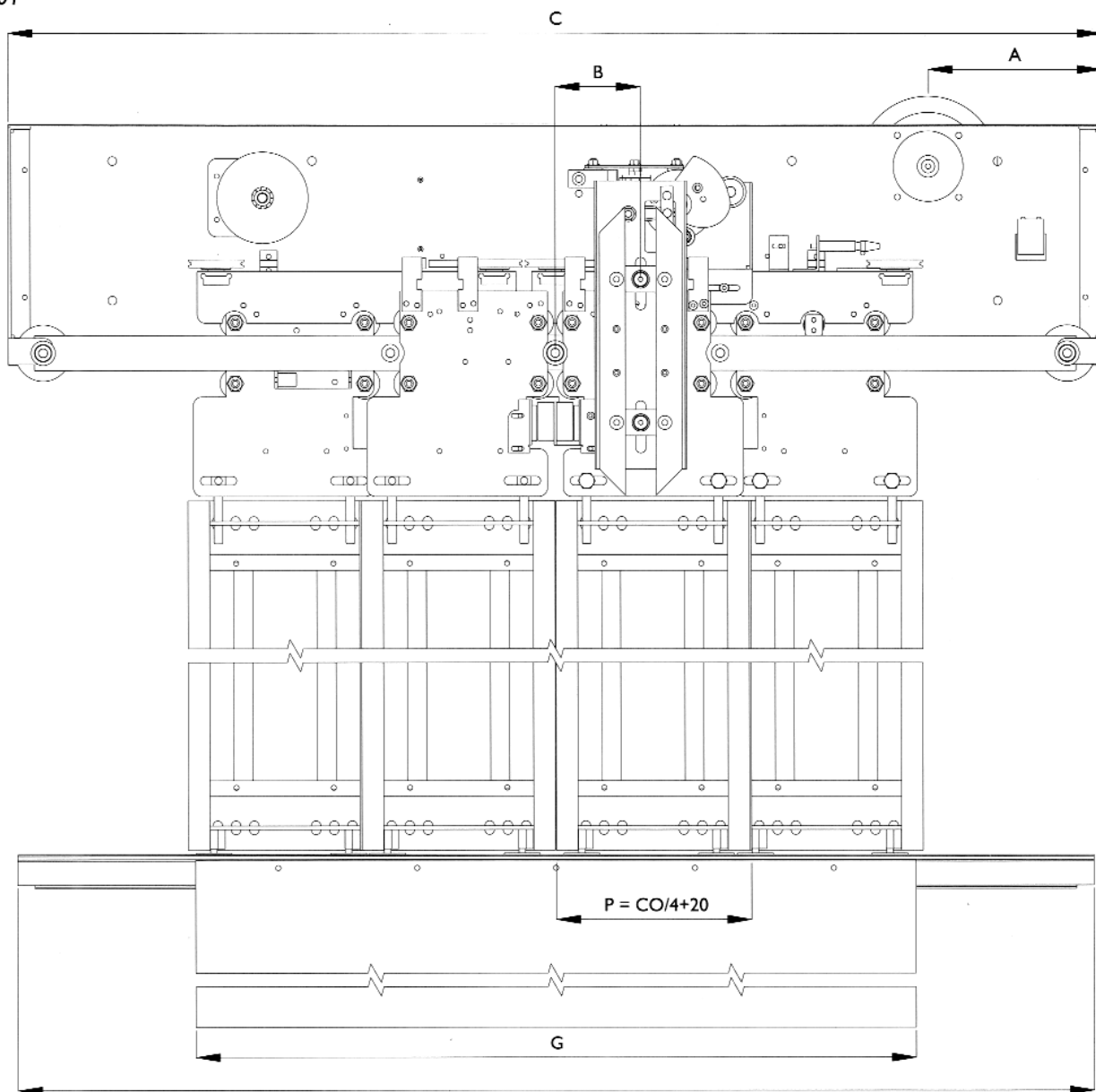

LONGUEUR SEUIL = CO+P+20

PORTE CABINE 4 VANTAUX OUVERTURE CENTRALE

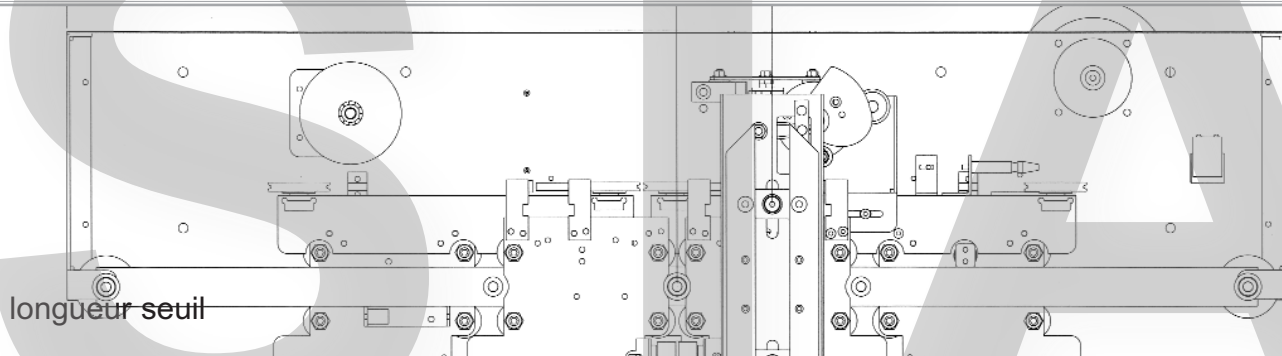

C4

Ver. 02

SUPPORT OPÉRATEUR OPTIONEL



VUE DESSUS OPÉRATEUR CABINE

PORTE CABINE 4 VANTAUX OUVERTURE CENTRALE

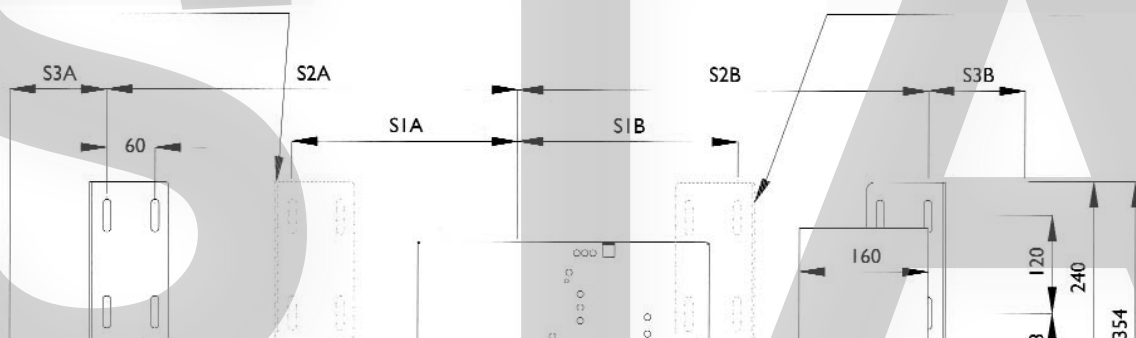

D5

Ver. 01

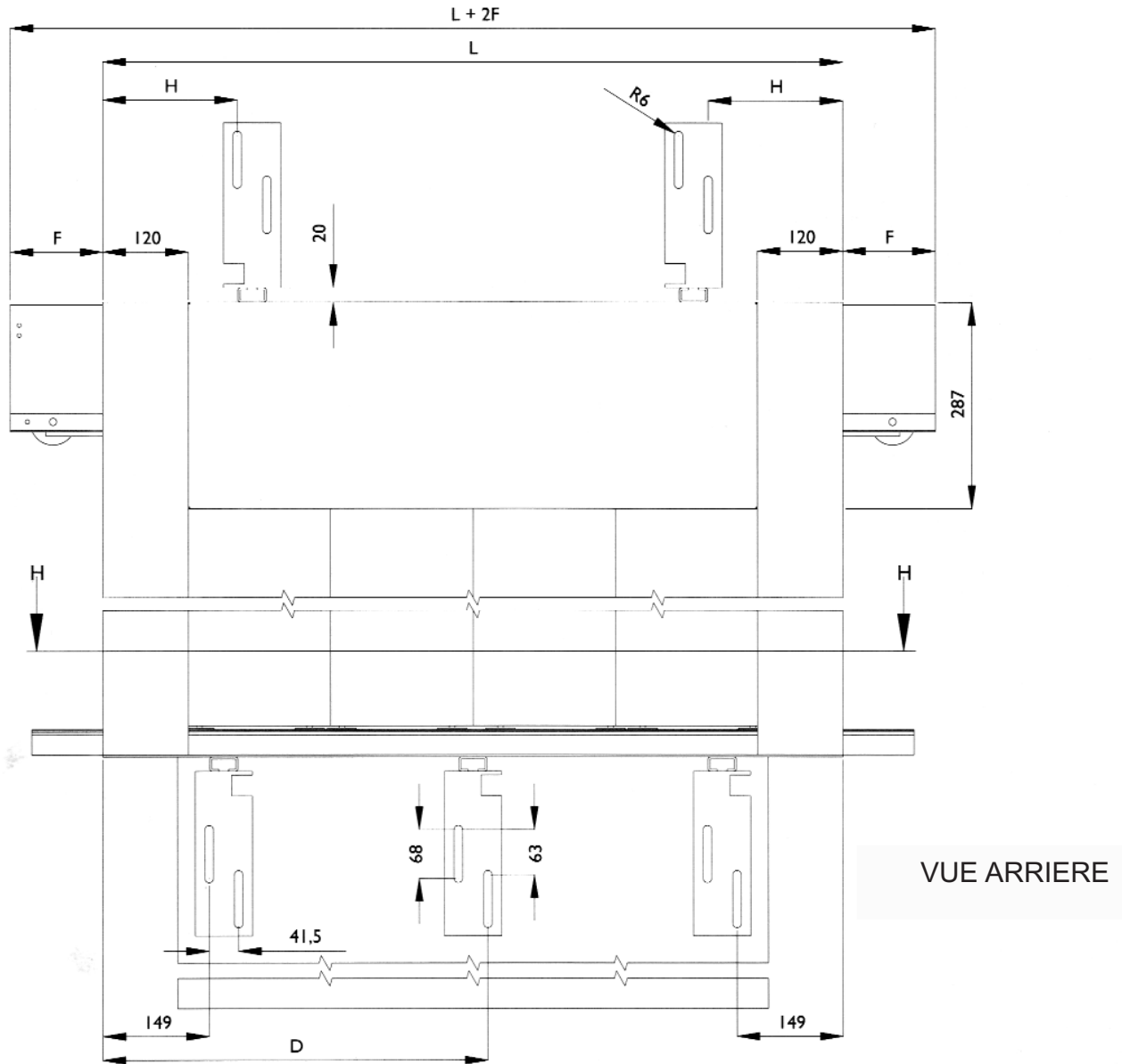

PORTE PALIERE 4 VANTAUX OUVERTURE CENTRALE



D6

Ver. 01

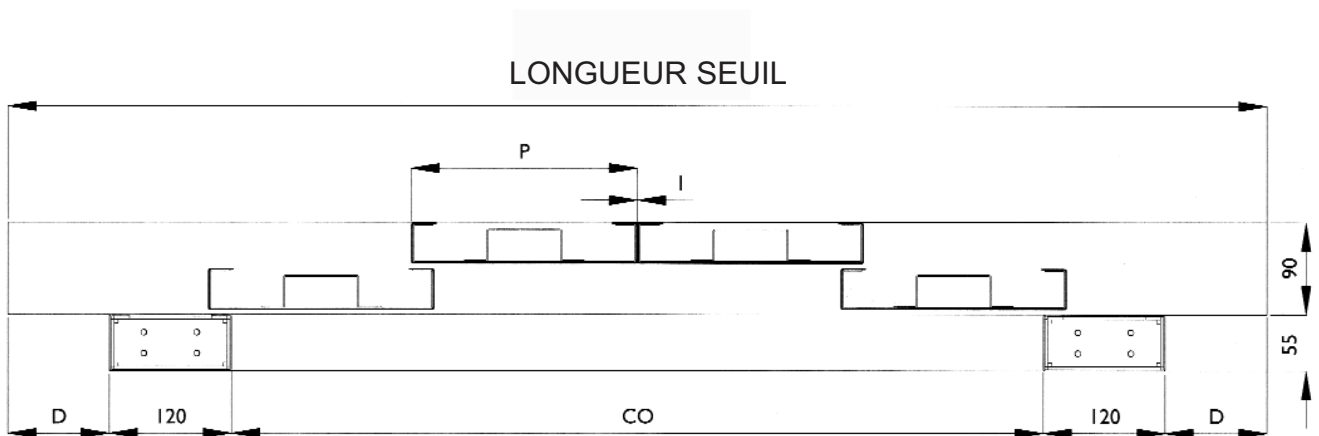

VUE DU PALIER

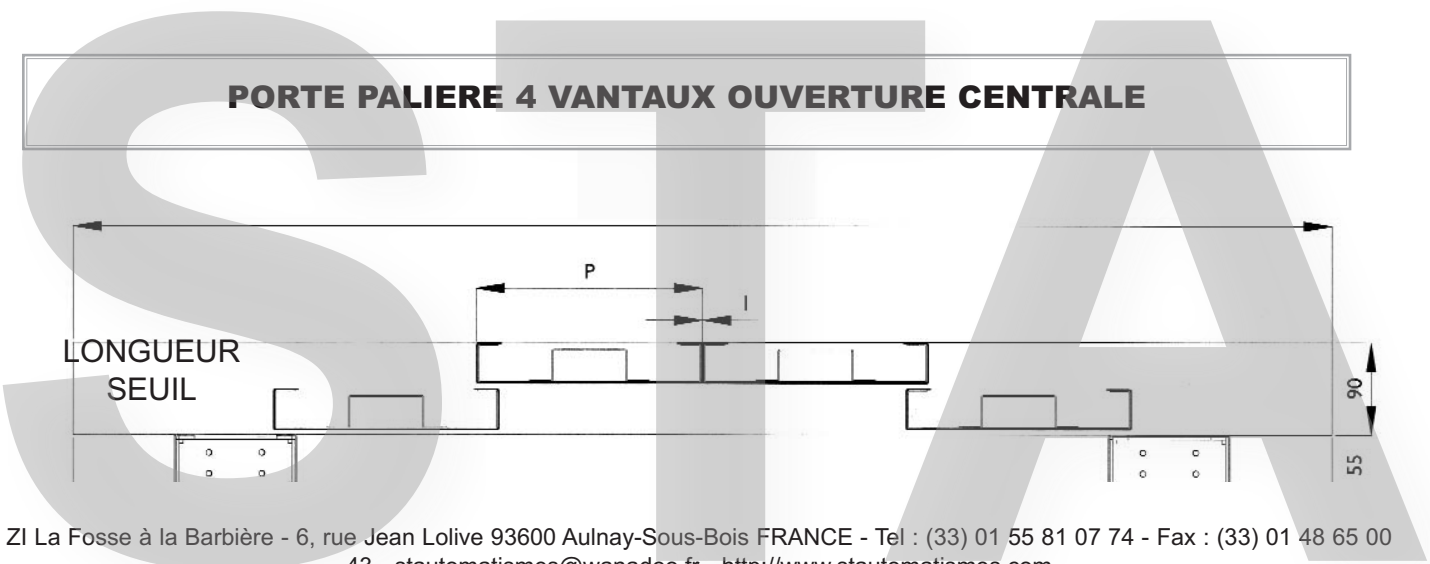

D7

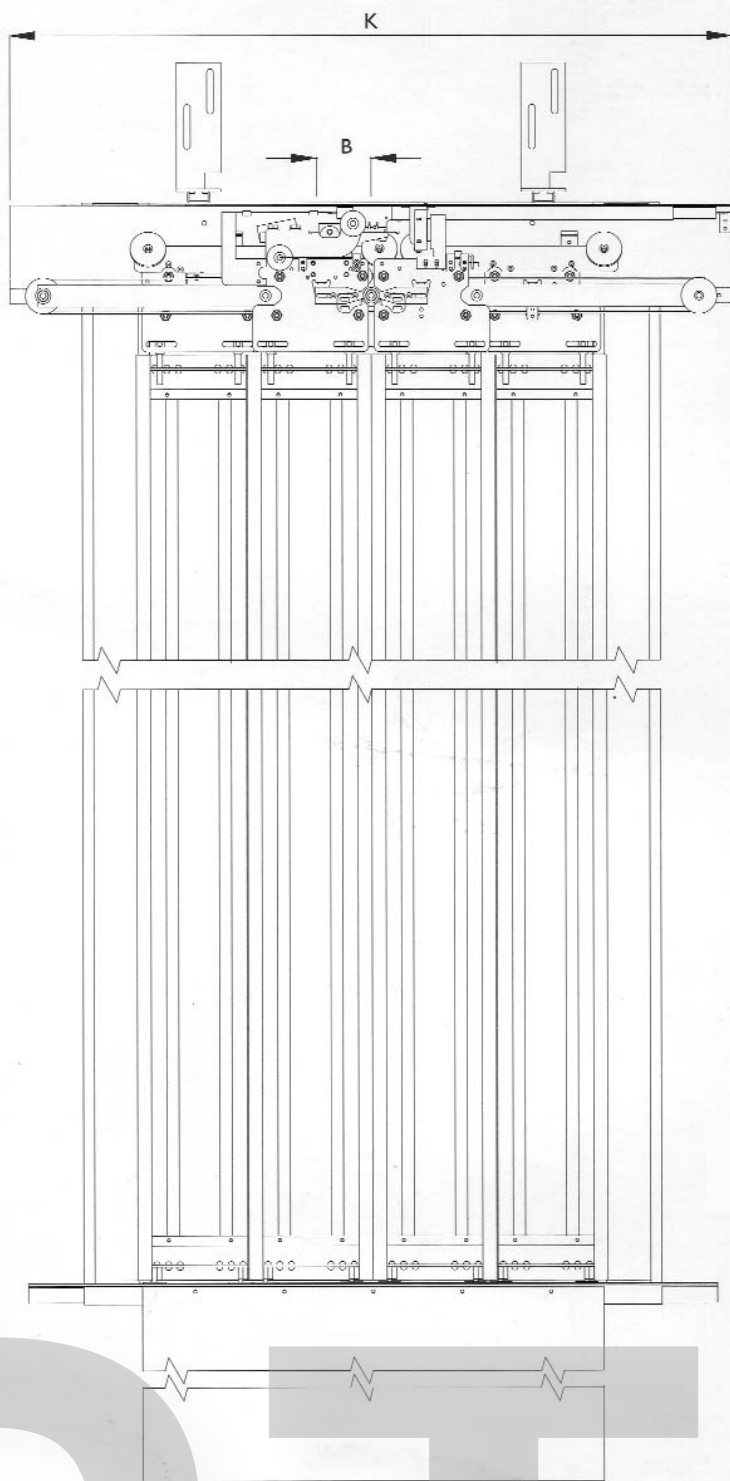

VUE ARRIERE

PORTE PALIÈRE 4 VANTAUX OUVERTURE CENTRALE

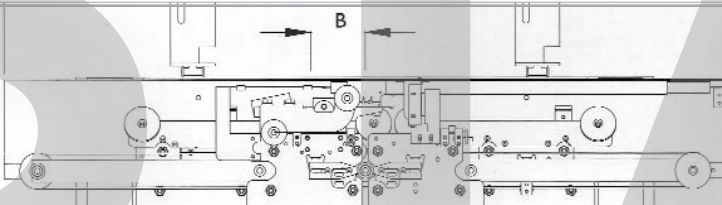

Y1

Ver. 02

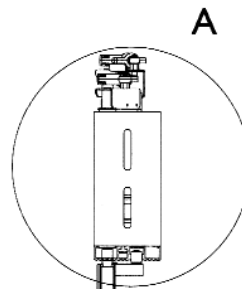
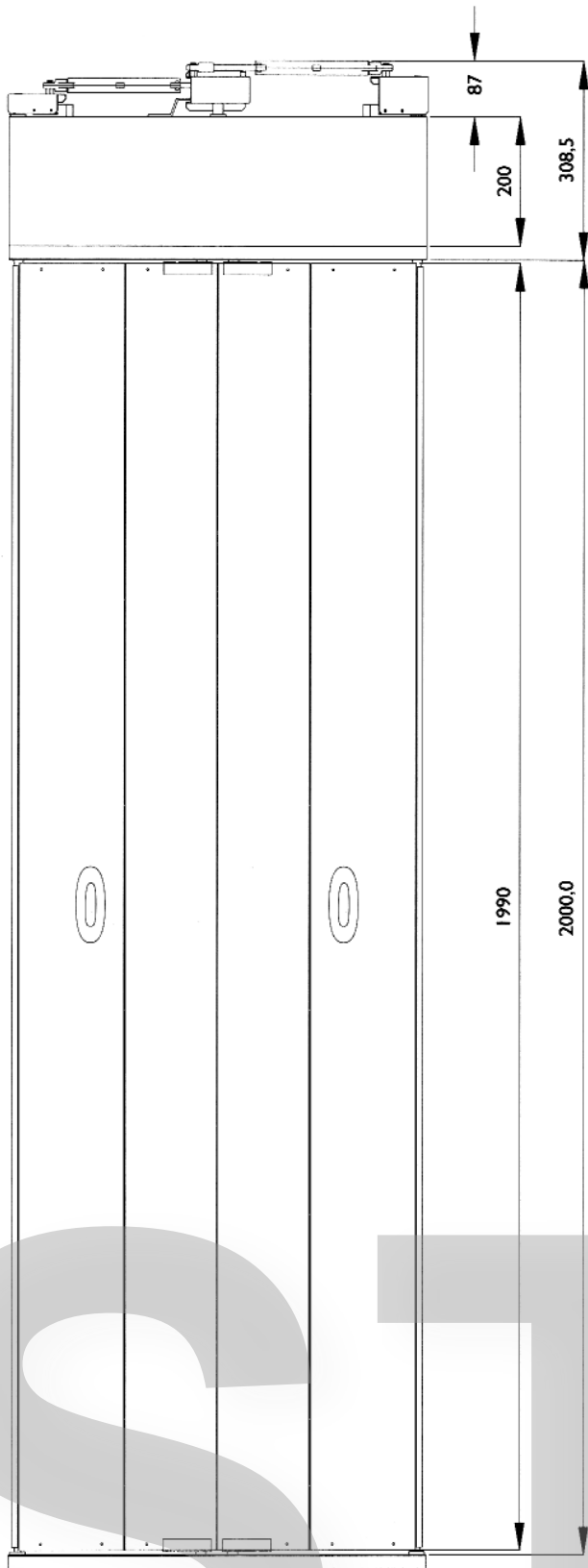

A

A (1:3)

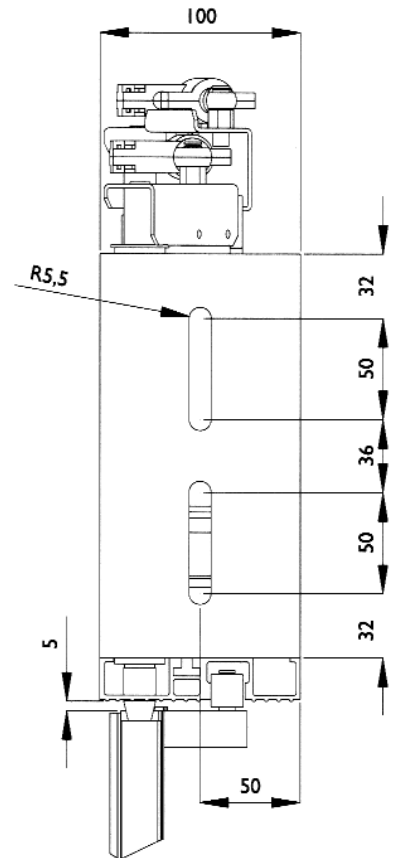

B (1:3)

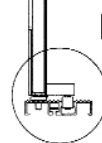

B

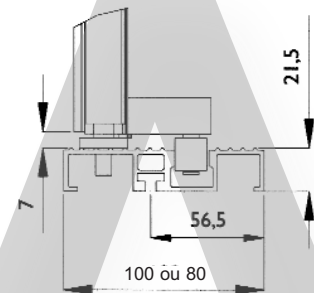

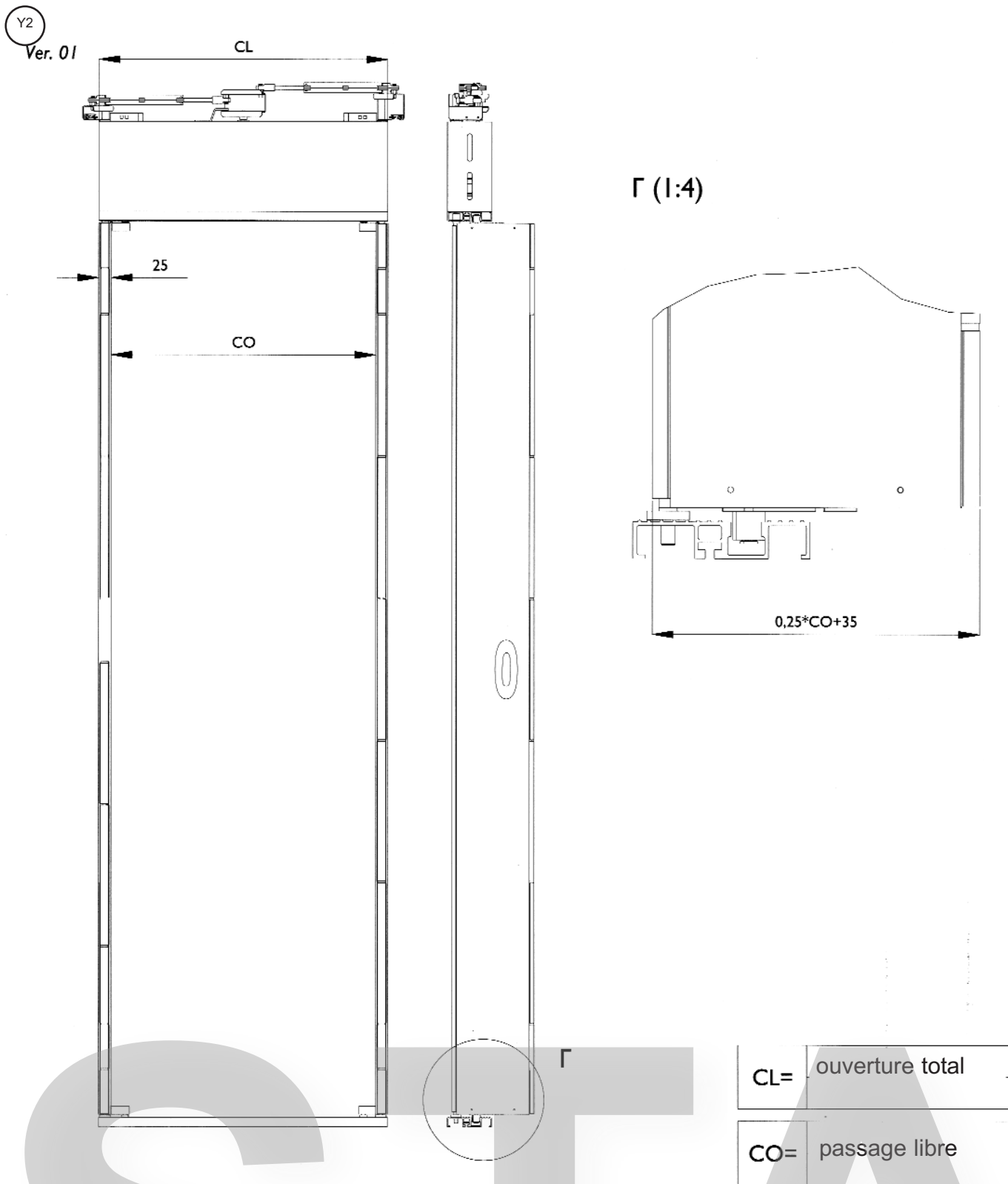

PORTE CABINE 4 VANTAUX (épaisseur opérateur 8 OU 10 CM)

CL	650	700	750	800	850	900	950	1000	1100	1200
CO	600	650	700	750	800	850	900	950	1050	1150